

2800

RF Power Analyzer



- Measure channel power for production testing of wireless phones, including new 3G technologies
- Measure adjacent and alternate channel bandwidth power
- 6ms CDMA primary channel power measurements
- 90dB wide band (cdmaOne) measurement range
- Frequency measurements with ± 1 Hz resolution

2800 RF Power Analyzer

Hardcopy user's manual,
RF Product Information
CD-ROM, rack mount kit,
bench assembly kit

The Model 2800 RF Power Analyzer is engineered specifically for the radio frequency (RF) test requirements of wireless phones, RFIC power amplifiers, and related RF power devices. Unlike bulky and expensive general-purpose spectrum analyzers, which offer a broad range of capabilities that test engineers must tailor to meet their specialized testing needs, the Model 2800 RF Power Analyzer includes only the capabilities required for wireless testing, all in a package that's optimized for high speed production environments. The result is a compact, ready-to-run instrument that's pre-configured

with the appropriate frequencies, channel numbers, offsets, and other test parameters specific to the latest wireless standards.

The Model 2800 is designed to be programmed and operated under computer control in automated test systems, eliminating unnecessary features like front panel graphic displays and extensive controls. Advanced digital signal processing (DSP) technology allows the Model 2800 to perform multiple measurements and mathematical operations simultaneously at extremely high speed, with minimal user programming. Its outstanding return on investment means adding the Model 2800 to test systems can help manufacturers of wireless phones and RF devices remain competitive.

Industry standards for wireless phone transmission require measuring power in certain specified bandwidths. The Model 2800 is designed for measuring power in the 800MHz cellular band, as well as the higher DCS (1700MHz) and PCS (1800MHz) bands, and the WCDMA (UMTS)/cdma2000 bands. In addition to measuring power in defined primary transmission channels, the Model 2800 can measure spurious or interfering power in the upper and lower channels adjacent to the primary channel, as well as the upper and lower alternate channels. Adjacent channel power measurements let test engineers determine adjacent channel power ratios (ACPR), which are needed to ensure wireless devices and components don't exceed the limits for spurious emissions/interference defined by industry standards. The Model 2800 is optimized for testing RFIC wireless phone power amplifiers and wireless phones designed to the AMPS, cdmaOne, North American Digital Cellular (NADC), GSM, GPRS, EDGE, DCS, cdma2000 1X, cdma2000 3X, and WCDMA standards. Contact the factory for information on testing for compliance to other standards.

Optimized for High Speed Production Testing

In high volume production testing, the ability to shave a few seconds off a device's test time can have a huge impact on a manufacturer's profitability. The Model 2800 offers power measurement speeds up to four times faster than other types of narrow-band RF power measurement instruments, such as spectrum analyzers. For example, it can make a CDMA primary channel transmission measurement and transfer the reading to an external controller via the IEEE-488 bus in just 6ms. It can even measure a CDMA primary channel transmission, its upper and lower adjacent channel spurious emission power, and its upper and lower alternate channel spurious emission power—and transmit all five measurements to the bus—in less than 30ms. Two simultaneous signal processing techniques make these fast concurrent measurements possible. Digital signal processing technology executes high speed algorithms to capture wide bandwidth power signals, such as the 1.23MHz cdmaOne and cdma2000 1X power transmissions. At the same time, digital filtering and digital downconversion signal processing technology capture the power in the two adjacent channels and the two alternate channels.

Manufacturers of devices that generate TDMA signals, such as GSM wireless phones and power amplifiers, can also reduce their test times dramatically with the Model 2800. It can capture and measure a 577 μ s pulsed GSM power transmission within the 4.6ms time slot cycle and be

APPLICATIONS

Production testing and automated environmental testing of:

- Wireless phones
- Wireless-enabled PDAs
- RFIC power amplifiers

1.888.KEITHLEY (U.S. only)

www.keithley.com

KEITHLEY

A GREATER MEASURE OF CONFIDENCE

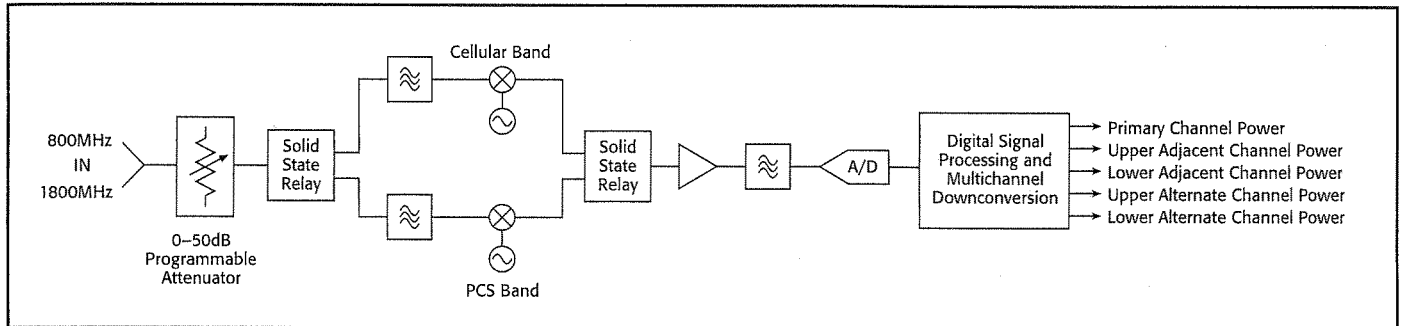

Figure 1. Model 2800 Front End Block Diagram. A unique signal processing configuration generates up to five power measurements in five different frequency bands simultaneously.

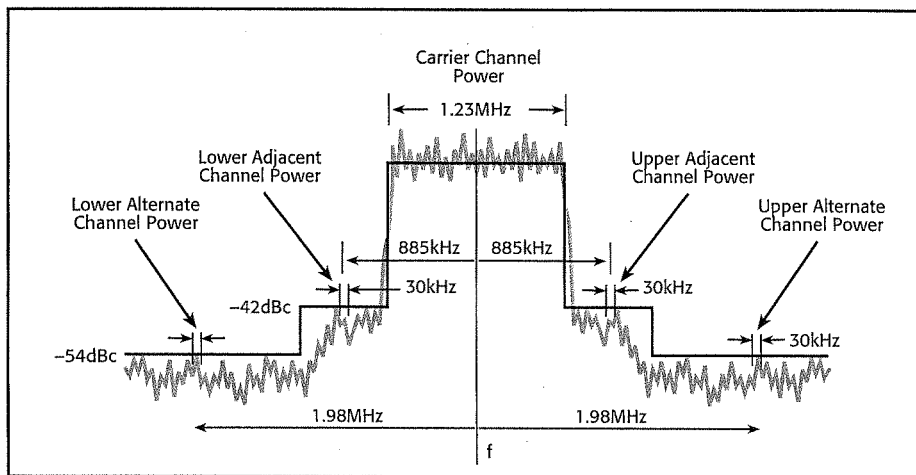

Figure 2. Power spectral density plot of a cdmaOne transmission, showing limits on adjacent channel power and alternate channel power. The Model 2800 can measure all five power levels in a single acquisition.

ready to measure the next consecutive pulse. In addition to capturing the pulse transmission's average power, the Model 2800 can simultaneously measure two adjacent or two alternate channel power levels by combining time domain and frequency domain signal processing on the RF power transmission.

Solid-state attenuation and solid-state switching enhance the Model 2800's reliability and minimize switching delays. Unlike electro-mechanical RF components, which often take milliseconds to switch signals, the Model 2800's solid-state architecture requires just microseconds. Rather than using the conventional technique of sweeping one oscillator over a wide frequency band, the Model 2800 employs multiple oscillators. In this way, it covers multiple narrow bands, substantially increasing the speed of frequency changes, so that power measurements in different channels can be performed very quickly. A high resolution, high speed A/D converter and a

90dB wide band (1.23MHz) measurement range reduce the number of attenuator range changes needed to measure a wide range of power levels. All these factors, combined with the control firmware designed to speed data transfer, allow the Model 2800 to reduce production test times substantially.

High Measurement Integrity

With 90dB of dynamic range, the Model 2800 can measure transmitted power outputs as low as -70dBm , even for wideband signals like 1.23MHz cdmaOne transmissions. The repeatability of all continuous wave (CW) primary channel power measurements is 0.05dB (0.1dB with modulated signals). Basic accuracy on primary channel power measurements down to -50dBm is 0.5dB. This high level of measurement integrity allows test engineers to hold manufacturing test limits to tighter tolerances to ensure greater confidence in measurement results and higher quality production yields.

Built entirely from digital circuitry from the intermediate frequency (IF) stage to the IEEE-488 bus, the Model 2800's design eliminates the potential for gain and frequency errors beyond the IF stage. Digital circuitry is immune to temperature variations, so the Model 2800's all-digital downconversion to baseband enhances measurement repeatability. Extensive digital filtering with sharp roll-offs further minimizes channel measurement error. In addition, the digital calibration process allows all internal error factors to be accumulated into one total error term for uncomplicated measurement error analysis. Finally, the VSWR of $<1.3:1$ ensures minimal measurement error due to power reflections at the instrument's input.

1.888.KEITHLEY (U.S. only)

www.keithley.com

KEITHLEY

A GREATER MEASURE OF CONFIDENCE

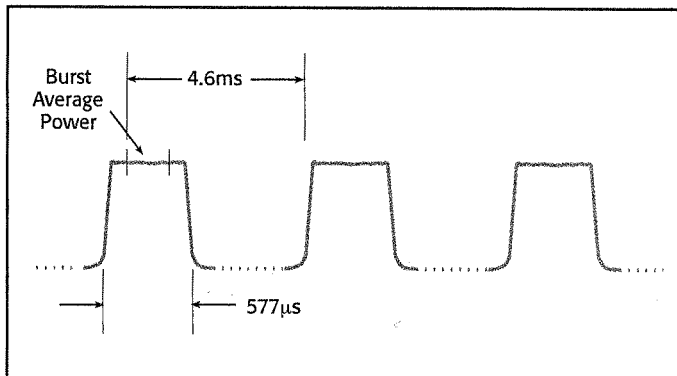

Figure 3. GSM RF pulse train. The Model 2800 has the speed to capture consecutive 577µs pulses.

The Model 2800's superior stability and the all-digital circuitry in the IF stage makes daily re-calibration unnecessary; yearly re-calibration is sufficient. To provide the most accurate measurements for DUT calibration procedures, system power losses due to cable and other component interconnections between the device-under-test (DUT) and the instrument can be stored in the Model 2800, then subtracted automatically from power measurements.

Simplified Manual and IEEE-488 Bus Operation

The menu that sets up the Model 2800 to make measurements based on one of the wireless phone standards can be accessed from a pushbutton on the instrument's front panel. The bandwidths for primary channel measurements and the frequency offsets and bandwidths for spurious measurements for the different standards are pre-programmed into the instrument. Test engineers can enter a frequency to program the Model 2800 to measure transmission power at a specific channel or, more conveniently, they can enter the channel number directly. For CDMA waveforms, the only other setting required to make a measurement is adjusting the internal attenuation for optimal measurement accuracy. TDMA measurements, such as the North American Digital Cellular standard and the GSM standard, require the same small number of steps, with the addition of programming a trigger to capture the TDMA pulse.

Optimizing the Model 2800 for a very specific set of test functions has simplified operation via the IEEE-488 bus. Just five IEEE-488 commands are needed to measure and transfer five readings (carrier channel power, upper adjacent channel power, lower adjacent channel power, upper alternate channel power, and lower alternate channel power) to the external PC controller. The Model 2800's control code is optimized to minimize test time. The use of block transfer techniques makes data transfer extremely efficient. A high speed test control mode based on Device Dependent Commands (DDCs) eliminates the overhead associated with using conventional SCPI commands. Specialized command sequences acquire multiple measurements for power level calibration and frequency compensation calibration.

Frequency Verification and Spectral Peak Analysis

To verify that a wireless phone transmitter and an RFIC power amplifier are transmitting in the correct channel, the Model 2800 has a function that detects the carrier signal's frequency and can measure it with ± 1 Hz resolu-

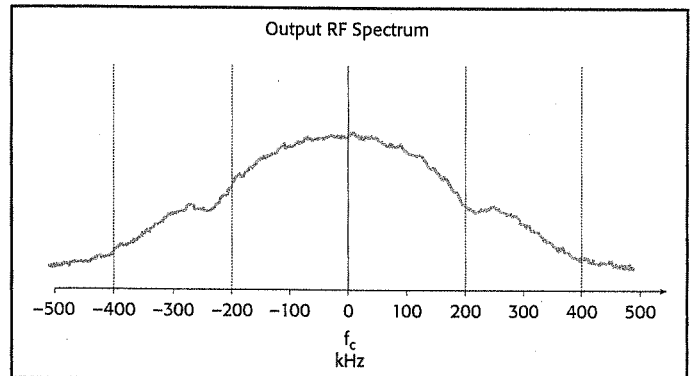

Figure 4. Power spectral density plot of a GSM transmission. The Model 2800 measures spurious emissions as well as capturing the power in the narrow pulses.

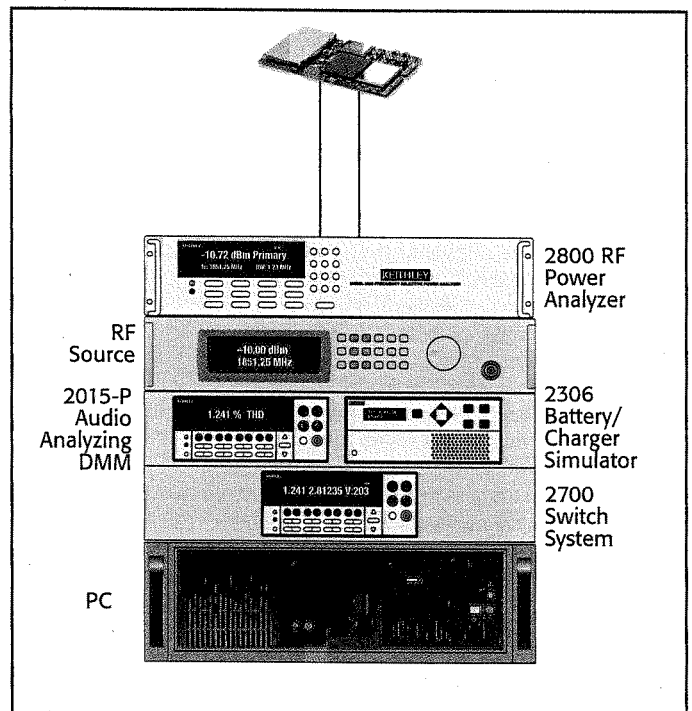

Figure 5. Mobile phone transmitter/receiver board calibration system. A high speed, simplified, low cost solution.

tion. The Model 2800 displays the difference between the programmed carrier frequency and the measured carrier frequency.

A built-in spectral peak detector can identify the peak of a power spectrum and sequential spectral peaks quickly. Identifying excessively high spurs makes it possible to assess the quality of the transmitted modulated signal.

1.888.KEITHLEY (U.S. only)

www.keithley.com

KEITHLEY

A GREATER MEASURE OF CONFIDENCE

RF/MICROWAVE SWITCH & MEASURE

2800

RF Power Analyzer

Fast, Cost-Efficient Wireless Phone PC Board Testing

With the Model 2800, an RF source, a Keithley battery simulating power supply, and a Keithley audio analyzing DMM, it's easy and economical to configure a high speed wireless phone transmitter/receiver calibration station. In fact, capital equipment costs for a Model 2800-based calibration station are roughly half the price of current test solutions. This system's high throughput can also cut test time and increase production capacity. It consumes no more than 6U of rack space, so one test rack can house multiple systems. A Model 2306 Dual-Channel Battery Charger/Simulator can monitor battery load currents in all states of operation and test for proper charger system operation. The Model 2015-P Audio Analyzing DMM can determine total harmonic distortion and frequency response of the microphone and speaker circuits to verify that audio performance meets specification. The Model 2800 calibrates the transmitter circuitry, and the RF source calibrates the wireless phone's receiver circuit. Keithley sales and application engineers can help determine the most appropriate RF source for specific testing requirements. Combining all these functions in a single easily maintained test system, a phone's transmitter/receiver circuitry can be calibrated thoroughly and economically.

To test multiple phones at a test station or to control test system automation, add a Model 2700 Switch System, which combines analog, digital, and microwave switching into one compact package.

Increased RFIC Power Amplifier Test Throughput

The Model 2800 can significantly increase test throughput when performing functional testing on an RFIC power amplifier. The Model 2800 can be easily combined with an RF source, and multiple Series 2400 SourceMeter® instruments to create a complete RFIC power amplifier test system.

The Series 2400 SourceMeter instruments make it simple to obtain precision amplifier load current measurements quickly. The Model 2800 and the RF source perform the characterization of the amplifier's RF output. The Series 2400s can interface directly with a device handler, eliminating the need for external control circuitry. To maximize throughput and instrument utilization, add a microwave switch system to integrate a dual device handler into the test system. By eliminating non-essential functionality and its associated costs, a Model 2800-based test system provides an economical test system that's easy to operate and maintain, and offers throughput superior to commercially available RFIC functional test systems.

Environmental Testing of a Large Number of Devices

Evaluating how RF devices will stand up to actual use typically requires obtaining statistically significant data on devices exposed to a wide range of temperatures. An environmental test system configured around a Keithley System 40 Microwave Switch System makes it possible to test a large number of devices simultaneously. The Model 2800's high measurement speed reduces the amount of test time needed, so more devices can

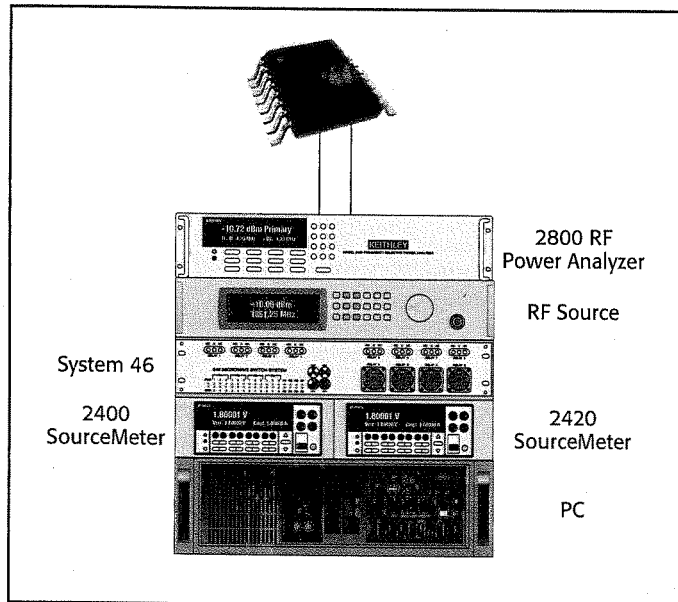

Figure 6. RFIC power amplifier functional test system. Throughput is greatly enhanced with instrumentation optimized for production test.

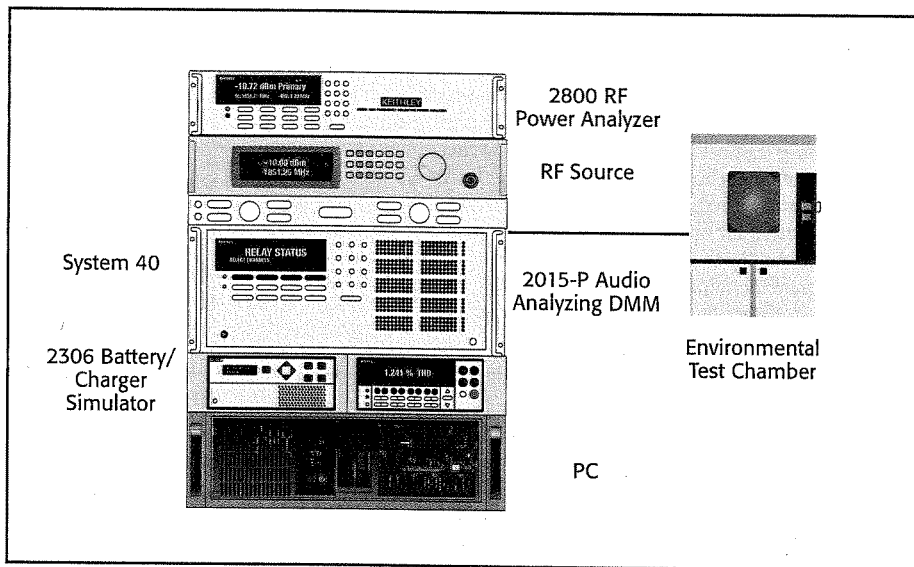

Figure 7. Multi-device system for environmental testing. Test a large number of devices at one time without extending test time.

be exposed to environmental testing during the allotted data collection schedule. Keithley applications engineers can assist with designing environmental test systems to meet specific requirements.

1.888.KEITHLEY (U.S. only)

www.keithley.com

KEITHLEY

A GREATER MEASURE OF CONFIDENCE

Specifications

FREQUENCY RANGE: 824–849MHz, 880–915MHz, 1710–1785MHz, 1850–1980MHz.

FREQUENCY SETTINGS:

CELLULAR STANDARD	CHANNEL NUMBER, N	CENTER FREQUENCY, MHz	FREQUENCY BAND, MHz
cdmaOne Cellular Band	1 – 799 990 – 1023	825.000 + 0.030*N 825.000 + 0.030*(N–1023)	824.01 MHz – 848.97 MHz
cdmaOne PCS Band	0 – 1199	1850.000 + 0.050*N	1850.00 MHz – 1909.95 MHz
North American Digital Cellular (NADC) Cellular Band	1 – 799 990 – 1023	825.000 + 0.030*N 825.000 + 0.030*(N–1023)	824.01 MHz – 848.97 MHz
North American Digital Cellular (NADC) PCS Band	1 – 1999	1849.980 + 0.030*N	1850.01 MHz – 1909.95 MHz
AMPS	1 – 799 990 – 1023	825.000 + 0.030*N 825.000 + 0.030*(N–1023)	824.01 MHz – 848.97 MHz
GSM Cellular Band (GSM 850)	128–251	824.2 + 0.2*(N–128)	824.2 MHz – 848.8 MHz
GSM Cellular Band (PGSM 900, E-GSM 900)	0 – 124 975 – 1023	890.0 + 0.2*N 890.0 + 0.2*(N–1024)	880.2 MHz – 914.8 MHz
DCS 1800 Band	512 – 885	1710.2 + 0.2*(N–512)	1710.2 MHz – 1784.8 MHz
GSM PCS 1900 Band	512 – 810	1850.2 + 0.2*(N–512)	1850.2 MHz – 1909.8 MHz
cdma2000 Band Class 0	1 – 799 991 – 1023	825.000 + 0.030*N 825.000 + 0.030*(N–1023)	824.04 MHz – 848.97 MHz
cdma2000 Band Class 1	0 – 1199	1850.000 + 0.050*N	1850.00 MHz – 1909.95 MHz
cdma2000 Band Class 4	0 – 599	1750.000 + 0.050*N	1750.00 MHz – 1779.95 MHz
cdma2000 Band Class 6	0 – 1199	1920.000 + 0.050*N	1920.00 MHz – 1979.95 MHz
cdma2000 Band Class 8	0 – 1499	1710.000 + 0.050*N	1710.00 MHz – 1784.95 MHz
cdma2000 Band Class 9	0 – 699	880.000 + 0.050*N	880.00 MHz – 914.95 MHz
WCDMA Operating Band 1	9612 – 9888	0.2*N	1922.4 MHz – 1977.6 MHz
WCDMA Operating Band 2	9262 – 9538 12, 37, 62, 87, 112, 137, 162, 187, 212, 237, 262, 287	0.2*N 1850.1 + 0.2*N	1852.4 MHz – 1907.6 MHz
WCDMA Operating Band 3	8562 – 8913	0.2*N	1712.4 MHz – 1782.6 MHz
Korean PCS	0 – 599	1750.000 + 0.050*N	1750.00 MHz – 1779.95 MHz
PHS	1 – 82 221 – 225	1895.15 + 0.3*(N–1) 1884.65 + 0.3*(N–221)	1884.65 MHz – 1919.45 MHz

INTERNAL REFERENCE OSCILLATOR REFERENCE:

Aging per Year: 1ppm.
Temperature Drift: (5° to 40°C): 0.5ppm.

EXTERNAL FREQUENCY REFERENCE INPUT:

Frequency: 10MHz ± 5ppm.
Power: ≥2dBm.
Input Impedance: 50Ω, nominal.

INPUT:

Connector: Type N female.
Impedance: 50Ω.
Maximum Overload Value: 24dBm, continuous, 20VDC.
VSWR: <1.2:1 with input attenuator >4dB.
<1.3:1 with input attenuator ≤4dB.

PRIMARY CHANNEL: MEASUREMENT RANGES

	cdmaOne	NADC	AMPS	GSM	cdma2000 1X	cdma2000 3X ²	WCDMA ²	PHS
Measurement Bandwidth ³	1.23 MHz	100 kHz	30 kHz	400 kHz	1.23 MHz	3.69 MHz	3.84 MHz	300 kHz/1 MHz
Accuracy (23°C ±5°C) ¹ : 20 dBm to –50 dBm	±0.5 dB	±0.5 dB	±0.5 dB	±0.5 dB	All Bands ±0.5 dB	All Bands ±0.5 dB	All Bands ±0.5 dB	±0.5 dB
–50.01 dBm to –60 dBm	Cell ±0.73 dB PCS ±0.73 dB	Cell ±0.73 dB PCS ±0.6 dB	Cell ±0.73 dB	Cell ±0.73 dB DCS ±0.6 dB PCS ±0.6 dB	All Bands ±0.73 dB	Band Class 0 ±0.6 dB ² Band Class 1 ±0.6 dB ² Band Class 4 ±0.6 dB ² Band Class 6 ±0.72 dB ² Band Class 8 ±0.6 dB ² Band Class 9 ±0.6 dB ²	Operating Band 1 ±0.73 dB Operating Band 2 ±0.6 dB Operating Band 3 ±0.6 dB	±0.7 dB
–60.01 dBm to –70 dBm ²	Cell ±1.07 dB PCS ±0.94 dB	Cell ±0.94 dB PCS ±0.94 dB	Cell ±0.94 dB	Cell ±0.94 dB DCS ±0.94 dB PCS ±0.94 dB	Band Class 0 ±1.07 dB Band Class 1 ±0.94 dB Band Class 4 ±1.02 dB Band Class 8 ±1.02 dB Band Class 9 ±1.65 dB			±0.9 dB
Repeatability: Mod. ³ CW ¹²	±0.1 dB ±0.05 dB	±0.1 dB ±0.05 dB	±0.1 dB ±0.05 dB	±0.1 dB ±0.05 dB	±0.1 dB ±0.05 dB	±0.1 dB ±0.05 dB	±0.1 dB ±0.05 dB	±0.1 dB ±0.05 dB
Noise Floor: Cellular Band DCS Band PCS Band	≤–77.5 dBm ≤–80.0 dBm	≤–88.6 dBm ≤–91.0 dBm	≤–89.0 dBm	≤–82.4 dBm ≤–82.9 dBm ≤–84.9 dBm	Band Class 0 ≤–77.5 dBm Band Class 1 ≤–80.0 dBm Band Class 4 ≤–73.2 dBm Band Class 6 ≤–73.6 dBm Band Class 8 ≤–78.0 dBm Band Class 9 ≤–75.0 dBm	Band Class 0 ≤–72.7 dBm Band Class 1 ≤–75.2 dBm Band Class 4 ≤–73.2 dBm Band Class 6 ≤–68.8 dBm Band Class 8 ≤–73.2 dBm Band Class 9 ≤–70.2 dBm	Operating Band 1 ≤–68.7 dBm Operating Band 2 ≤–75.1 dBm Operating Band 3 ≤–73.1 dBm	≤–82 dBm

1.888.KEITHLEY (U.S. only)

www.keithley.com

KEITHLEY

A GREATER MEASURE OF CONFIDENCE

ADJACENT CHANNEL (Primary Channel Input Signal in Range 5dBm to 20dBm)

	cdmaOne	NADC	GSM	cdma2000 1X	cdma2000 3X	WCDMA	PHS ²⁰
Measurement Bandwidth ⁹	30 kHz	25 kHz	30 kHz	30 kHz	30 kHz	3.84 MHz	192 kHz
Offset from Cellular Center Frequency	±885 kHz, ±900 kHz	±30 kHz	±200 kHz	±885 kHz, ±900 kHz			
	DCS, PCS ±900 kHz, ±1250 kHz	±30 kHz	±200 kHz	±900 kHz, ±1250 kHz	±2.65 MHz	±5 MHz	600 kHz
Range at Specified Accuracy ¹⁵	>55 dBc	>36 dBc	>40 dBc	>55 dBc	>55 dBc	>33 dBc	<-42 dBm
Accuracy (23°C ±5°C) ¹ Relative to primary channel	±1.0 dB	±1.0 dB	±1.0 dB	Band Classes 0, 1, 4, 8, 9: ±1.0 dB Band Class 6: 1.5 dB	Band Classes 0, 1, 4, 8, 9: ±1.0 dB Band Class 6: 1.5 dB	±2.0 dB ²	±1.0 dB
Repeatability ³ CW	±0.5 dB ⁴	±0.5 dB ¹¹	±0.5 dB ¹¹	±0.5 dB ⁴	±0.5 dB ⁴	±1.0 dB ²	±0.5 dB ¹¹

ALTERNATE CHANNEL (Primary Channel Input Signal in Range 5dBm to 20dBm)

	cdmaOne	NADC	GSM	cdma2000 1X	cdma2000 3X	WCDMA	PHS ²⁰
Measurement Bandwidth ⁹	30 kHz	25 kHz	30 kHz	30 kHz	30 kHz	3.84 MHz	192 kHz
Offset from Cellular Center Frequency	±1.98 MHz	±60 kHz	±400 kHz	±1.98 MHz			
	DCS, PCS ±1.98 MHz	±60 kHz	±400 kHz	±1.98 MHz	±3.10 MHz	±10 MHz	900 kHz
Range at Specified Accuracy ¹⁵	>55 dBc	>48 dBc	>60 dBc	>55 dBc	>55 dBc	>43 dBc	<-42 dBm
Accuracy (23°C ±5°C) ¹ Relative to primary channel	±1.0 dB	±1.0 dB	±1.0 dB	Band Classes 0, 1, 4, 8, 9: ±1.0 dB Band Class 6: 1.5 dB	Band Classes 0, 1, 4, 8, 9: ±1.0 dB Band Class 6: 1.5 dB	±2.0 dB ²	±1.0 dB
Repeatability ³ CW	±0.5 dB ⁴	±0.5 dB ¹¹	±0.5 dB ¹¹	±0.5 dB ⁴	±0.5 dB ⁴	±1.0 dB ²	±0.5 dB ¹¹

OTHER MEASUREMENTS
UPPER SIDEBAND POWER (AMPS STANDARD ONLY):

Measurement of Power Relative to Carrier @ 10kHz Offset:
 Frequency Range: 824–849MHz.
 Carrier Measurement Bandwidth: 1kHz.
 Level: 20dBm to -40dBm.
 Accuracy: ±0.5dB.
 Dynamic Range: 28dB.

CARRIER FREQUENCY

Frequency Range¹⁶: 824–849MHz, 880–915MHz, 1710–1785MHz, 1850–1980MHz.

Resolution: 1Hz.

Displayed Value: Difference between measured frequency and entered center frequency.

Measurement Window: ±90kHz, nominal, from entered channel number or center frequency.

Level: 20dBm to -25dBm.

Accuracy: ±1Hz (with external reference).

PEAK FUNCTION: Computes power level and frequency of 5 highest power components in primary channel power spectrum.

Range: 824–849MHz, 880–915MHz, 1710–1785MHz, 1850–1980MHz.

Frequency Resolution: 5kHz.

Displayed Values: Power in dBm, frequency in MHz.

Measurement Window: ±1.82MHz from entered channel number or center frequency.

Level: 20dBm to -25dBm.

Level Accuracy: ±0.5dBm¹⁸.

GSM BURST POWER WAVEFORM ACQUISITION: Acquires 577ms power burst.

Parameters Computed: rise time, maximum and minimum power levels of rising transient edge, maximum and minimum power levels of information transfer portion of burst.

Sample Time resolution: 1μs.

Power Accuracy: ±0.5dB.

Number of Waveform Samples: 620.

OCCUPIED BANDWIDTH (PHS Only): Bandwidth that contains 99% of measured power.

Frequency Resolution: 1.667kHz.

TRIGGER METHODS:

	Latency
Level	3 μs
External Trigger	100 μs
IEEE-488 Bus Command	2.5 ms

1.888.KEITHLEY (U.S. only)

www.keithley.com

KEITHLEY

A GREATER MEASURE OF CONFIDENCE

MEASUREMENT PARAMETERS

	cdmaOne	NADC	GSM	cdma2000 1X	cdma2000 3X	WCDMA	PHS
Trigger Delay	Range	0–999.999 ms	0–12.790 ms	0–3.990 ms	0–999.999 ms	0–999.999 ms	0–3.990 ms
	Resolution	1 μ s	3 μ s	1 μ s	1 μ s	1 μ s	1 μ s
Acquisition Time	Primary Channel	200 μ s	100 μ s–999.999 ms	100 μ s–3.990 ms	200 μ s	200 μ s	100 μ s–3.990 ms
	Adjacent/Alternate Channel	100 μ s–999.999 ms	100 μ s–999.999 ms	100 μ s–3.990 ms	100 μ s–999.999 ms	100 μ s–999.999 ms	100 μ s–3.990 ms
	Resolution	3 μ s	7 μ s	1 μ s	3 μ s	3 μ s	1 μ s
Number of Averages	1–100	1–100	1–100	1–100	1–100	1–100	1–100

MEASUREMENT TIME (Typical)⁷:

	cdmaOne	NADC ¹¹	AMPS	GSM ¹¹	cdma2000 1X	cdma2000 3X	WCDMA	PHS
Primary Channel Power Measurement ⁵	6 ms	11 ms ¹³	40 ms	4 ms ¹³	6 ms	7 ms	7 ms	4 ms ¹⁵
Primary Channel Power Measurement, Two Adjacent Channel Power Measurements, and Two Alternate Channel Power Measurements ^{5, 6}	26 ms	16 ms ^{10, 13}	N/A	10 ms ^{10, 13}	26 ms	26 ms	75 ms ¹⁷	10 ms ^{10, 13}
Time to complete 10 different power measurements at a single frequency ^{5, 8, 14}	80 ms	141 ms ¹³	330 ms	81 ms ¹³	80 ms	88 ms	94 ms	81 ms ¹³
Time to complete 10 power measurements of a single power level at different frequencies ^{5, 14}	122 ms	371 ms ¹³	390 ms	325 ms ¹³	160 ms	165 ms	225 ms ¹⁷	325 ms ¹⁵

NOTES:

- Based on measurements of NIST traceable CW signals, and locked to the source reference. Exclusive of input mismatch. Derate by $\pm 0.05\text{dB}/^\circ\text{C}$ beyond $23^\circ\text{C} \pm 5^\circ\text{C}$.
- For CDMA2000 3X and WCDMA measurements between -50.01dBm and -60dBm , accuracy values are based on an average of 6 measurements.
- Defined as 2 standard deviations of 100 consecutive readings while measuring a modulated signal.
- Measurement acquisition time: 10ms.
- Range: 20dBm to -60dBm (except cdma2000 3X and WCDMA which are for 20dBm to -50dBm), averaging off, display off, input protection off, temperature compensation off, binary transfer, and 488.1 protocol. For measurements of only the primary channel, the adjacent channel measurements and the alternate channel measurements are disabled.
- Adjacent channel power and alternate channel power measurement acquisition time: 10ms.
- Times are defined at specified repeatability and include IEEE-488 transfer times. CDMA2000 3X and WCDMA repeatability specifications are excluded.
- Includes time required to make two attenuator changes.
- Bandwidths are designed to conform to definitions in cellular standards.
- Measurement times include 3 measurements: primary channel power measurement and upper and lower adjacent channel power measurement.
- Acquisition time is one time slot: NADC = 6.0ms, GSM, PHS = 500 μ s. Level trigger is used.
- Defined as 2 standard deviations of 100 consecutive measurements spaced evenly over an 8 hour period with ambient temperature of $23 \pm 1^\circ\text{C}$. The following conditions apply: default acquisition times and signal/noise $> 30\text{dB}$.
- Pulse measurement times are defined from the time the rising edge of each power pulse is detected to the completion of the data transfer.
- Times are exclusive of DUT settling times.
- The range is defined as the maximum detectable difference between the primary channel power and the adjacent (or alternate) channel power for the specified accuracy and specified measurement bandwidth.
- Defined for measurements on un-modulated carrier waveforms, cdmaOne, and cdma2000 1X modulated waveforms.
- Times are based on measurements in Operating Band One.
- Defined for signals whose carrier is at the programmed center frequency or offset by an integer multiple of 5kHz.
- Defined with 0dB programmed attenuation, $23^\circ\text{C} \pm 5^\circ\text{C}$, input terminated with 50 Ω , and 100 readings averaged.
- PHS channel power must be between $+10\text{dBm}$ and -10dBm .

1.888.KEITHLEY (U.S. only)

www.keithley.com

KEITHLEY

A GREATER MEASURE OF CONFIDENCE

GENERAL

PROGRAMMABILITY: IEEE-488.2 (SCPI-1995.0), 3 user-definable power-up states plus factory default and *RST.

MEMORY BUFFER: 2500 sets of 5 readings – primary channel power, upper and lower adjacent channel power, upper and lower alternate channel power, with time stamp, peak reading, average reading, and standard deviation.

DIGITAL INTERFACE: Digital I/O: 1 digital input, 4 digital outputs with 250mA sink capability, maximum clamp voltage 30VDC, 5V @ 100mA DC source.

REAR CONNECTIONS: RF Input (Type N connector); External Trigger, Meter Complete, External Reference In, and Cal Output (BNC); Digital I/O (DB9); IEEE-488 (24-Pin EMI shielded receptacle); Power (Power Switch/Line Entry Module with DPDT switch, 2 fuses, and IEC 320 plug).

POWER SUPPLY: 100V/120V/220V/240V

LINE FREQUENCY: 50Hz to 60Hz.

POWER CONSUMPTION: 100VA.

ENVIRONMENT:
 Operating: 5°–40°C, 70% R.H., non-condensing, up to 35°C.
 Storage: 0°–50°C.

WARRANTY: 1 year.

SAFETY: Complies with European Union Directive 73/23/EEC, EN61010-1.

EMC: Complies with European Union Directive 89/336/EEC, EN61326-1.

VIBRATION: MIL-PRF-28800F Class 3 Random.

WARM-UP: 1 hour to rated accuracy.

DIMENSIONS:
 Bench configuration (with handle and feet): 104mm high × 485mm wide × 478mm deep (4.125 in × 19 in × 18.75 in).
 Rack Mounting: 89mm high × 485mm wide × 478mm deep (3.5 in × 19 in × 18.75 in)

WEIGHT: Net Weight: 13.14 kg (28.9 lbs). Shipping Weight: 14.5kg (32 lbs).

ACCESSORIES SUPPLIED: Hardcopy User's manual, RF Product Information CD-ROM, rack mount kit, bench assembly kit.

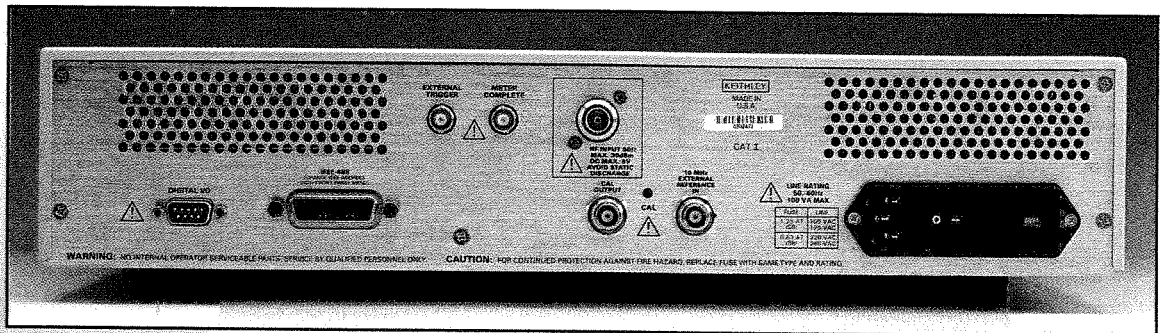

Figure 8. Rear panel of 2800 showing Type N input connector, external reference input, calibration output, external trigger and measurement complete BNC connectors, IEEE-488 connector, and DB9 digital I/O relay control lines connector.

1.888.KEITHLEY (U.S. only)

www.keithley.com

KEITHLEY

A GREATER MEASURE OF CONFIDENCE